

INSTRUCTION MANUAL

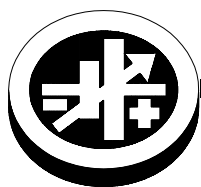

KEPCO An ISO 9001 Company.

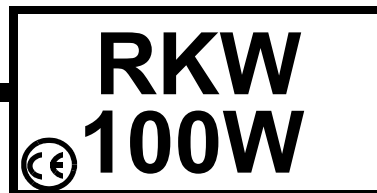

100 WATT SINGLE OUTPUT, PFC, OPEN FRAME POWER SUPPLIES

I — INTRODUCTION

SCOPE OF MANUAL. This instruction manual covers the installation and operation of the Kepco RKW 100W Series of Open Frame PFC (Power Factor Corrected) Switching Power Supplies.

DESCRIPTION. The Kepco RKW 100W Series consists of seven models of switching power supplies, with a single output as shown in Table 1. Units may be operated with a nominal 100V a-c to 240V a-c (input voltage range 85 to 265 Va-c), 50-60 Hz (input frequency range 47-66Hz; units operate up to 440Hz although leakage current, power factor and efficiency specifications may not be met.). They will also operate on 110V to 370V d-c input. The RKW 100W Series employs a forward converter with a fixed switching frequency of 135KHz. Power Factor Correction (PFC) is provided by a boost converter operating at 80KHz. Regulation is provided by pulse width modulation. A thermistor circuit prevents excessive turn-on current surge. Remote programming of output voltage using an external resistance can be implemented. Overvoltage and overcurrent protection is provided. Current limiting with automatic recovery from short circuit is featured. Units are convection cooled L-chassis construction. A steel cover (Model CA 35) is available as an option.

Section II contains specifications and operating limits of individual RKW 100W Series models (Table 1) as well as specifications and operating limits common to all RKW 100W Series Models. Section III describes installation and Section IV describes operation

II — SPECIFICATIONS

The following specifications are at nominal input voltages at 25°C unless otherwise specified.

TABLE 1. OUTPUT RATINGS AND SPECIFICATIONS, RKW 100W SERIES

MODEL	RKW 3.3-25K	RKW 5-20K	RKW 12-8.5K	RKW 15-7K	RKW 24-4.5K	RKW 28-3.8K	RKW 48-2.1K
OUTPUT VOLTS, d-c	3.3V	5V	12V	15V	24V	28V	48V
ADJUSTMENT RANGE, Vd-c	2.85-4.0	4.0-5.8	9.6-13.2	12-16.5	19.2-26.4	22.4-30.8	38.4-52.8
OUTPUT CURRENT (AMPS) -10 to +50 °C	25	20	8.5	7	4.5	3.8	2.1
CURRENT LIMIT ⁽²⁾ (AMPS)	26.25 min	21 min	8.92 min	7.35 min	6.82 min	3.99 min	2.2 min
SHORT CIRCUIT CURRENT ⁽²⁾ (AMPS)	37.5	27.5	11.5	10	10	7.5	4.5
OVP SETTING ⁽¹⁾ (VOLTS)	4.2-5.2	6.0-6.9	13.7-15.7	17.0-19.0	27.0-30.5	32.0-35.0	55.0-60.0
EFFICIENCY	100 Va-c	74%	77%	80%	80%	81%	83%
	240 Va-c	77%	82%	84%	84%	85%	86%
RIPPLE AND NOISE ⁽³⁾ (mV p-p)	Switching ripple (typ)	80	80	100	100	100	130
	spike noise (typ) ⁽²⁾	120	120	150	150	150	200
External Potentiometer ⁽⁴⁾	1K Ohms	1K Ohms	2K Ohms	2K Ohms	5K Ohms	5K Ohms	10K Ohms

(1) An overvoltage shuts down the output. Recover by recycling a-c input (30 second delay required before resetting).

(2) The current limit is rectangular. After the overload is removed, output is automatically restored.

(3) Bandwidth 100 MHz. Ripple and noise will be approximately 1.5 times these values in the operating temperature range -10 ~ 0°C. The ripple and noise values tabulated are valid when the output is derated as shown in figure 2 from 50 ~ 65°C

(4) Used for remote programming of output voltage. See Section IV OPERATION, REMOTE VOLTAGE PROGRAMMING.

INPUT VOLTAGE:

Nominal 100-240V a-c, range: 85-265V a-c (0 to 100% load, -10 to 71°C); d-c range: 110 -370V d-c.

INPUT SOURCE FREQUENCY:

Nominal 50/60 Hz; Range 47-66 Hz (0 to 100% load, -10 to 71°C), at 440 Hz the leakage current exceeds the VDE safety specification limit.

INPUT CURRENT:

5V-48V models: 1.4A max. (100-120 Va-c input, 100% load); 0.7A max. (200-240 Va-c input, 100% load).

3.3V model: 1.2A max. (100-120 Va-c input, 100% load); 0.6A max. (200-240 Va-c input, 100% load).

INPUT PROTECTION AND SOFT START: A thermistor circuit reduces start-up surge. Units are protected against shorts by an input fuse. Fuse value 3.15A, 250V Littlefuse P/N 2153.15MF018, Kepco P/N 541-0135)

INPUT SURGE: cold start 25 °C (First surge only, not including the current flow into the EMI filter)

14A typ. (100 V a-c, 100% load); 28A typ. (200 Va-c, 100% load).

LEAKAGE CURRENT:

0.35mA max, 0.23mA typ at 120V a-c and 60 Hz, 0.70mA max, 0.45mA typ at 240V d-c and 60 Hz (operating in conformance with UL 1950/IEC 950).

KEPCO, INC. • 131-38 SANFORD AVENUE • FLUSHING, NY. 11352 U.S.A. • TEL (718) 461-7000 • FAX (718) 767-1102

<http://www.kepcopower.com> • email: hq@kepcopower.com

POWER FACTOR: 0.99typ. at 100 Va-c, 0.95 typ. at 200 Va-c.

STABILIZATION:

Source Effect: (85 to 132Va-c, 170-265 Va-c) 0.1% typ., 0.2% max.
Load Effect: measured at sensing terminals: (0% - 100% of rated output current) 0.1% typ., 0.4% max.
Temperature effect: (-10 to 71°C) 0.5% typ., 1.0% max.
Combined effect: 0.9% typ., 1.8% max.
Drift: (1/2 to 8 hr. at 25°C) 0.2% typ., 0.5% max.

TRANSIENT RECOVERY: A step load change from 50% to 100% of rated output current in 50 microseconds or more, produces no more than 4% output voltage excursion. Recovery time is 1ms maximum.

OUTPUT HOLDING TIME: With 100 Va-c input voltage: upon input interruption the output is maintained for 37 milliseconds typical (20 ms min.); with 240 Va-c input voltage: 45 milliseconds typical (25ms min.).

START UP TIME: 500ms max., 300ms typ. at 100 Va-c; 200ms max., 100ms typ. at 240 Va-c.

OVERVOLTAGE PROTECTION: Fixed, factory set. See Table 1. The overvoltage circuit is set by Zener diode clamp, latching will occur.

OVERCURRENT: Square type, output voltage returns to rated level upon removal of cause of malfunction.

OPERATING TEMPERATURE: -10 to 50°C (start up -20 to -10°C). See the derating, Figure 1. Do not allow the power supply to become dust covered because that will decrease the cooling efficiency of the unit and cause insulation to deteriorate.

STORAGE TEMPERATURE: -30°C to + 75°C.

COOLING: Natural convection.

ORIENTATION: Vertical or horizontal.

HUMIDITY: 10% to 95% relative humidity, operating and storage, noncondensing, wet bulb temperature < or = 35°C.

WITHSTANDING VOLTAGE

(at 15 to 35°C ambient, 10 to 85% relative humidity, cutout current 20 ma):
Between input and output terminals, 3.0 KV a-c for 1 minute.
Between input terminals and ground, 2000V a-c for 1 minute.
Between output terminals and ground, 500V a-c for 1 minute.

INSULATION RESISTANCE: Between input and output, input and ground, output and ground: 100 megohms minimum (500V d-c, 15 to 35°C ambient, 10 to 85% relative humidity).

VIBRATION: Three axes, one hour each, sweep time 10 min., nonoperating 5-10 Hz., 10 mm amplitude.
10-200 Hz., 2G (19.6m/s²).

SHOCK: Three axes, 60G (588m/s²), 11ms ±5 msec pulse duration, three shocks each axis, nonoperating, 1/2 sine pulse.

EMC - EMISSIONS:

Radiated Noise 30MHz to 1GHz: FCC Class B, VCCI-B, EN55011-B, EN55022-B
Conducted Noise 0.15MHz to 30MHz: FCC Class B, VCCI-B, EN55011-B, EN55022-B
Input Harmonics (on AC Mains) 0 to 2KHz: EN 61000-3-2.

EMC - IMMUNITY:

ESD: EN 61000-4-2 Level 4, Normal operation.
Radiated Field Noise: EN 61000-4-3 Level 3, Normal operation.
Electrical Fast Transient/Burst (EFT): EN 61000-4-4 Level 3, Normal operation.
Surge: EN 61000-4-5 Level 4, no damage.
Conducted Noise: EN 61000-4-6 Level 3, Normal operation.
Power Frequency Magnetic Field: EN 61000-4-8 Level 4, Normal operation.
Voltage Dips, Short Interruptions, Voltage Variation: EN 61000-4-11, Normal operation.

SAFETY: All units designed to meet EN 60950 (U.S. UL 60950 3rd Ed.; Canada: CAN/CSA-22.2 No. 60950-00 3rd Ed. (ambient temp. 50°C)). RKW 100W units are CE marked per the Low Voltage Directive (LVD), EN60950. [The standards do not apply with DC input operation.]

WEIGHT: 21 oz. (600 grams) max

WARRANTY: One year.

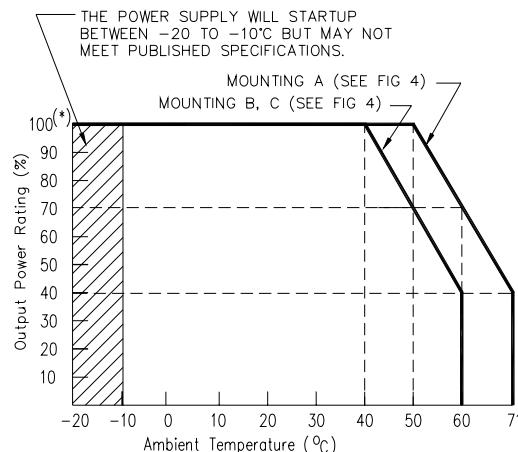

3042477

FIGURE 1. OUTPUT POWER VS. TEMPERATURE

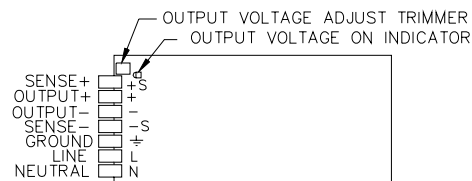

3042480

FIGURE 2. COMPONENT LOCATIONS

III — INSTALLATION

MOUNTING THE POWER SUPPLY: Refer to Figures 4 and 5. The unit may be mounted on one mounting surface. Note the restrictions for maximum penetration of mounting screws. The air surrounding the power supply must not exceed the ambient values given in the graph in Figure 1.

CONNECTIONS: Connect the load to the power supply as shown in Figure 3A, B, or C. The unit is shipped with shorting links in place for Local sensing. The AC input power is applied via the terminal block. Make sure to connect the AC input Neutral, Line and Ground wires to the respective terminals of the terminal block (see Figure 2). **Sensing (either Local or Remote) MUST be used.**

LOCAL/REMOTE SENSING: Figure 3 shows proper connection of multiple loads using either remote or local sensing. **If local or remote sensing is not configured, the unit will not work properly.** The unit is shipped with shorting links in place for Local sensing. For remote sensing, remove the shorting links and connect the +S and -S terminals to the load. Remote sensing compensation is up to 0.4V per load wire (0.15V for RKW 3.3-25K, 0.25V for RKW 5-20K). Transient recovery specs may not be met when remote sensing is used. If oscillations set off overvoltage protection, install one electrolytic capacitor (470µF min) between +S and + and one between - and -S terminals.

IV — OPERATION

When output voltage is available, the green LED is on. The Output Voltage Adjust trimmer (see Figure 2) allows adjustment of the output voltage within the range specified in Table 1.

REMOTE VOLTAGE PROGRAMMING: In addition to the integral trimmer, output voltage can be also be adjusted via an external variable resistance (see Figure 3B). The variable resistance specified in Table 1 must be substituted for the shorting link between + and +S terminals. Note that load effect for RKW 100W is increased using this technique, and may exceed values listed above under STABILIZATION.

SERIES OPERATION: When a number of power supplies are operating in series, the current rating is to be limited to the rating of the power supply with the lowest rating. A diode ($V_r > 2 \sum V_o$, $I_f > 2I_o$, $V_f \ll \text{low}$) must be connected to the power supply output terminals to protect the unit from reverse voltage.

PARALLEL OPERATION: Identical units may be operated in parallel for increased current capability. Use either local or remote sensing for all supplies in the parallel group.

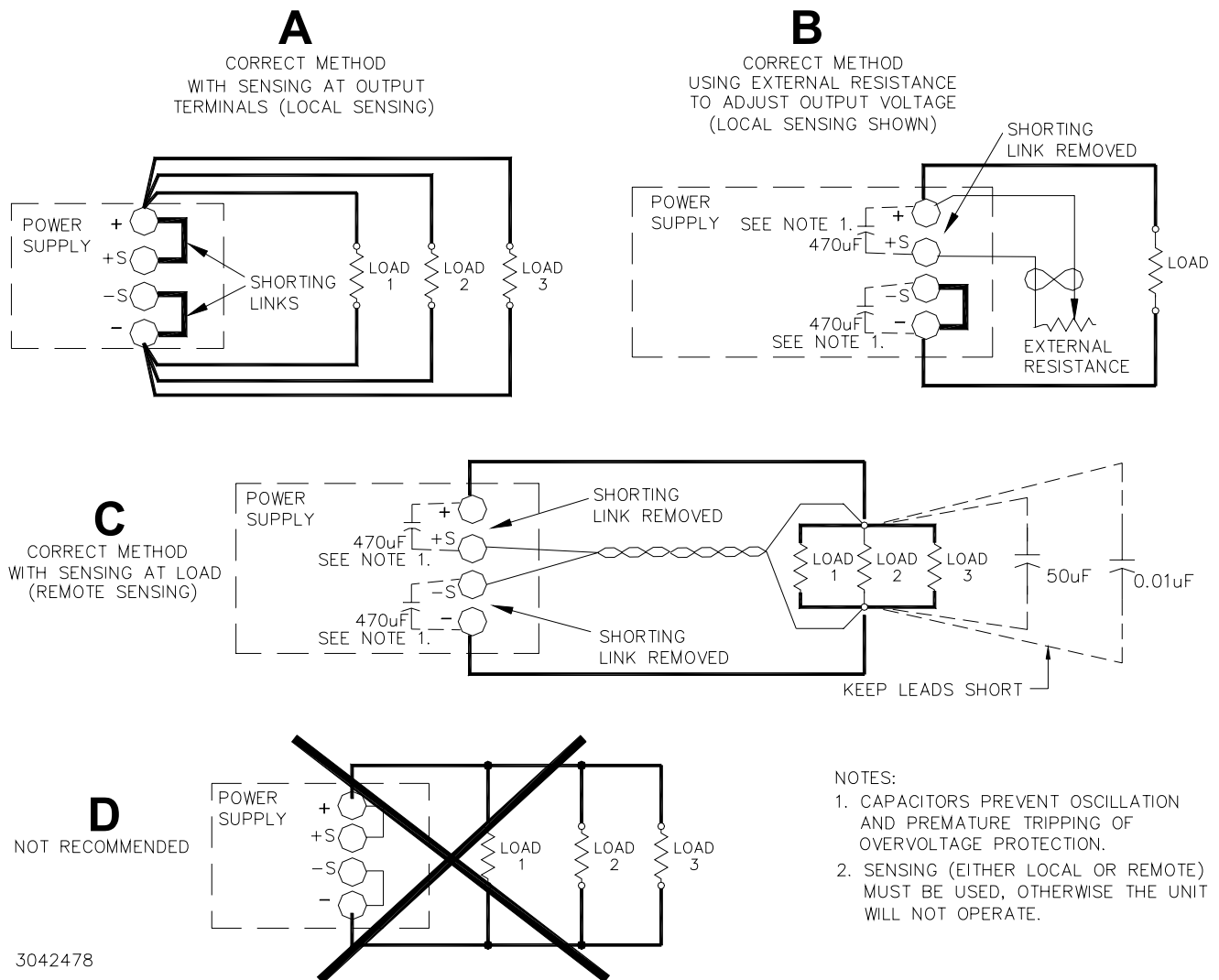
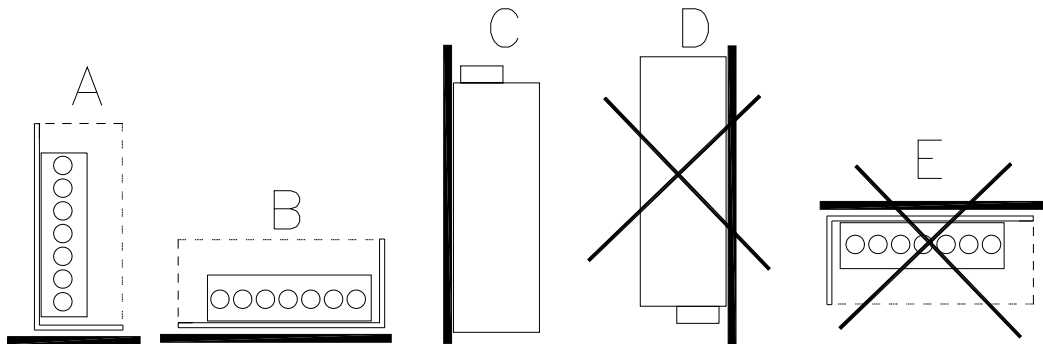

FIGURE 3. LOAD CONNECTIONS



NOTES:
 1. METHODS D AND E ARE NOT RECOMMENDED DUE TO INSUFFICIENT VENTILATION.
 2. REFER TO FIGURE 1 FOR OUTPUT POWER VS. TEMPERATURE FOR MOUNTING METHOD SELECTED.

3042479

FIGURE 4. POWER SUPPLY MOUNTING

NOTES:
 1. MAX PENETRATION OF M4 MOUNTING SCREWS IS 0.24 (6) FROM CASE SURFACE.
 2. ± 0.04 (± 1) TOLERANCE UNLESS OTHERWISE SPECIFIED.
 3. DIMENSIONS ARE IN INCHES, DIMENSIONS IN BRACKETS () ARE IN MILLIMETERS.
 4. REFER TO FIGURE 4 FOR MOUNTING ORIENTATION.

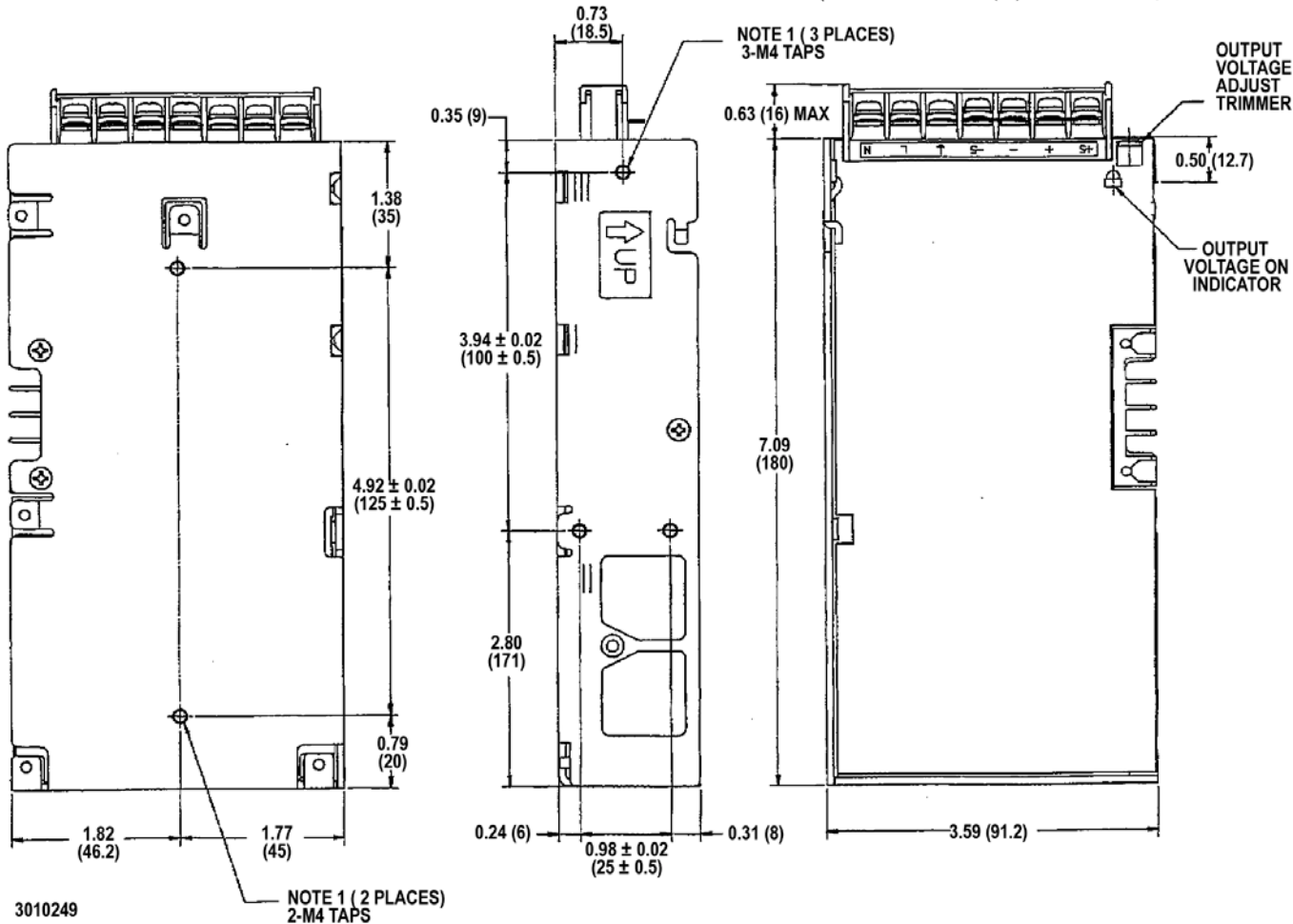
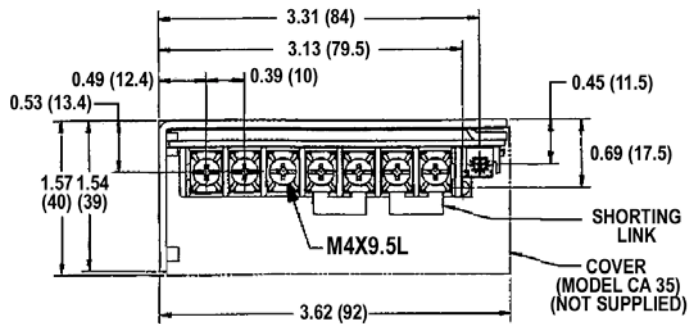

3010249

FIGURE 5. RKW 100W MECHANICAL OUTLINE DIAGRAM

KEPCO, INC. • 131-38 SANFORD AVENUE • FLUSHING, NY. 11352 U.S.A. • TEL (718) 461-7000 • FAX (718) 767-1102
<http://www.kepcopower.com> • email: hq@kepcopower.com
 228-1445 REV 4